

WILLBRANDT Rubber Expansion Joint Type 42

DN 50 - DN 3000



















Type 42 is a handmade, high-corrugated rubber expansion joint. Its high corrugation helps to achieve very low inherent resistance. It is characterised by its flexible installation length and variety of rubber qualities, which means that a suitable rubber compound is available for every application (see material descriptions). The expansion joint can also be produced in high-pressure versions up to 100 bar.

Type 42 is used in plant engineering, water technology and wastewater technology, where it is mainly used in the event of repairs if the existing gap does not correspond to any standard installation length. This avoids expensive full renovation on the piping system. It absorbs noise, vibration and pipe movement.



Bellow design	High corrugated rubber bellow with reinforcement and pressure-resistant shaped solid rubber flanges, self-sealing (no additional seals required). Suitable for backing flanges or vulcanised steel flanges (for high-pressure applications).	Pressure resistance	Design according to customer specification, max 100 bar operating pressure.
Flange version	Both sides with backing or vulcanised flange made of galvanized steel with clearance holes, drilled according to DIN PN 10 (standard). Other materials and dimensions are possible.	Vacuum resistance	Only vacuum-resistant with a vacuum supporting ring. Also available as a special version with a vulcanised vacuum supporting ring on the corrugation foot.
		Accessories	<ul style="list-style-type: none"> - Guide sleeves - Potential equalisation - Flame-resistant protective covers - Dust and splash protection covers - Earth cover / sun protection hoods - Segment tie rods

Specifications

Bellow		Bellow design			Max. temperature °C	Permissible operating data									
Colour code	Colour marking	Core (inner)	Reinforcement	Cover (outer)		°C	bar	°C	bar	°C	bar	°C	bar	°C	bar
red		EPDM	Polyamide	EPDM	100										
blue		EPDM TW	Polyamide	EPDM	100										
white/red		EPDM beige	Polyamide	EPDM	100										
red		EPDM AF	Polyamide	EPDM	100										
green		CSM	Polyamide	CSM	100										
yellow-grey		NBR	Polyamide	CR	100										
white-grey		NBR beige	Polyamide	CR	100										
grey		CR	Polyamide	CR	90										
red-blue-red		EPDM	Aramid	EPDM	100										
blue-blue-blue		EPDM TW	Aramid	EPDM	100										
white-blue-red		EPDM beige	Aramid	EPDM	100										
orange-blue-orange		EPDM HT	Aramid	EPDM HT	125										
red-blue-red		EPDM AF	Aramid	EPDM	100										
green-blue-green		CSM	Aramid	CSM	100										
yellow-blue-grey		NBR	Aramid	CR	100										
white-blue-grey		NBR beige	Aramid	CR	100										
grey-blue-grey		CR	Aramid	CR	90										
lilac-blue-lilac		FPM	Aramid	FPM	180										
-	-	Silicone	Aramid	Silicone	180										
-	-	Silicone	Glass fabric	Silicone	200										

Important information

For aggressive media, please see the resistance table (can be requested separately).
 The bellow should not be painted or insulated. Please refer to the installation instructions.
 ++++ We will be happy to send you further information on the individual types and designs.++++

WILLBRANDT Rubber Expansion Joint Type 42

Application

Type 42 red (EPDM)

For water, sea water, cooling water with glycol or other chemical additives for treating water, saline solutions, weak acids and weak alkaline solutions. Unsuitable for aliphatic, aromatic and chlorinated hydrocarbons, oil or oily media.

Type 42 blue (EPDM TW)

Like Type 42 red, but approved for drinking water.

Type 42 white-red (EPDM beige)

Like Type 42 red, but with light-coloured rubber in food-grade.

Type 42 red AF (EPDM AF)

Like Type 42 red, but with abrasion-resistant EPDM rubber compound.

Type 42 green (CSM)

For chemicals, aggressive, chemical wastewater and compressor air containing oil.

Type 42 yellow-grey (NBR)

For oils, fats, gases, diesel fuels, kerosene and crude oil. Not suitable for aromatic and chlorinated hydrocarbons, esters and ketones.

Type 42 white-grey (NBR beige)

Like Type 42 yellow-grey, but with light-coloured internal rubber in food-grade. Not approved for drinking water!

Type 42 grey (CR)

For water, wastewater, swimming pool water, salt water, cooling water with anti-corrosive products containing oil, oil mixtures and compressed air containing oil.

Type 42 red-blue-red (EPDM/aramid)

Like Type 42 red, but with aramid fabric.

Type 42 blue-blue-blue AF (EPDM TW/aramid)

Like Type 42 blue, but with aramid fabric.

Type 42 white-blue-red AF (EPDM beige/aramid)

Like Type 42 white-red, but with aramid fabric.

Type 42 orange-blue-orange AF (EPDM HT/aramid)

Like Type 42 red, but with aramid fabric and for temperatures up to +125 °C.

Type 42 red-blue-red AF (EPDM AF/aramid)

Like Type 42 red AF, but with aramid fabric.

Type 42 red-blue-red AF (EPDM AF/aramid)

Like Type 42 red AF, with aramid fabric.

Type 42 green-blue-green (CSM/aramid)

Like Type 42 green, but with aramid fabric.

Type 42 yellow-blue-grey (NBR/aramid)

Like Type 42 yellow-grey, but with aramid fabric.

Type 42 white-blue-grey (NBR white/aramid)

Like Type 42 white-grey, but with aramid fabric.

Type 42 grey-blue-grey (CR/aramid)

Like Type 42 grey, but with aramid fabric.

Type 42 lilac-blue-lilac (FPM/aramid)

For flue gas desulphurisation systems and bio-diesel. High chemical resistance to benzene, xylene, toluene, aromatic, chlorinated hydrocarbons, mineral acids and fuels with an aromatic content of more than 50 %. Temperatures of up to +180 °C.

Type 42 silicone (silicone/glass fabric or aramid)

Suitable for hot air, acetic acid. Satisfactory resistance to aliphatic engine and gear oils. Also available in foodstuff quality. Excellent resistance to ageing, UV, ozone and weather. Very good radiation resistance. Not for use with steam above 120 °C. No resistance to fuels.

Note!

Detailed material descriptions on pages 5 - 7.



WILLBRANDT Rubber Expansion Joint Type 42

Versions

Type 42 is produced with pressure-resistant solid rubber flanges. In order to ensure a tight connection to the pipe/fan, the counter flange should be flat and have no raised face. If this is not possible, the expansion joint flange can be produced with a negative recess (see Versions 2 and 4) in order to accommodate the raised face of the counter flange and ensure a flat connection.

Alternatively, spacer rings can be used.

Version 1

Both sides with pressure-resistant solid rubber flanges for flat counter flanges.

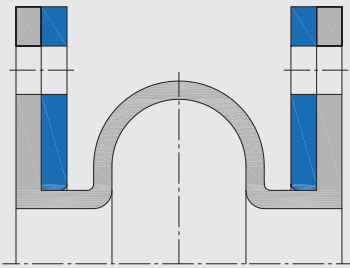

Version 2

Both sides with pressure-resistant solid rubber flanges and negative recess for counter flanges with raised face.

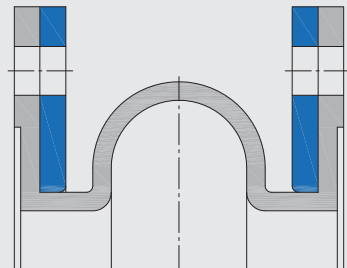

Version 3

Both sides with pressure-resistant solid rubber flanges and vulcanised supporting rings at the corrugation foot.

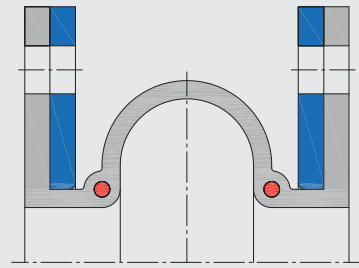

Version 4

Both sides with pressure-resistant solid rubber flanges and negative recess for counter flanges with raised face and vulcanised supporting rings at the corrugation foot.

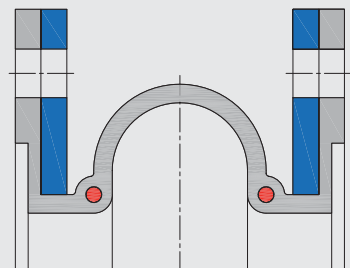

Version 5

Both sides with pressure-resistant solid rubber flanges, vulcanised corrugated supporting rings at the corrugation foot and filled corrugation.

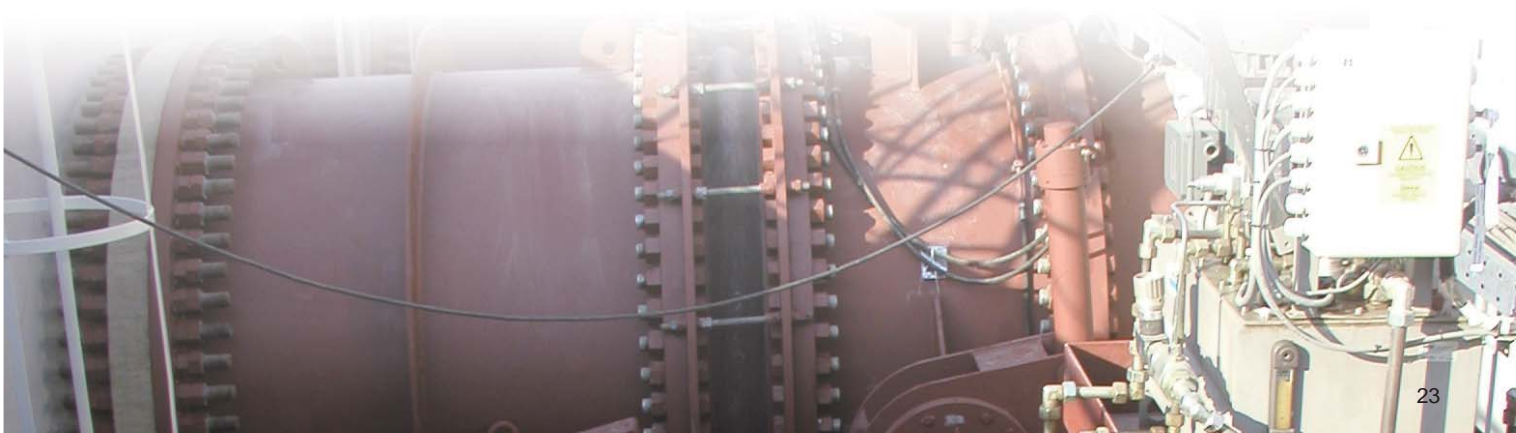
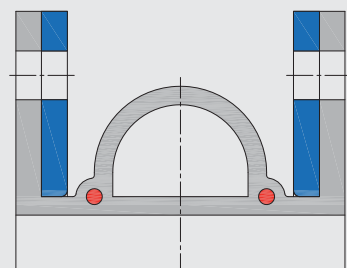

WILLBRANDT Rubber Expansion Joint Type 42

Design A - without tie rods

Can be used for movement absorption in any direction (for combined movements, see the movement diagram in the technical appendix), noise and vibration insulation.

The expansion joint's reaction force must be absorbed via suitable piping (see fitting instructions in the appendix).

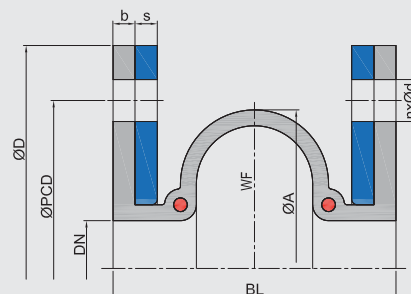

(Example illustration - Version 3)

Dimensions for Design A

DN	Overall length BL*1	ØA	Bellow b	WF*2	Flange PN 10*3					Movement absorption*4			
					mm	mm	mm	mm ²	ØD	ØPCD	Ød	n	s
50	200	110	10	6360	165	125	18	4	20	10	20	15	10.0
65	200	125	10	8650	185	145	18	8	20	10	20	15	10.0
80	200	140	10	11300	200	160	18	8	20	10	20	15	10.0
100	200	160	10	15400	220	180	18	8	20	14	34	15	15.6
125	200	185	10	21370	250	210	18	8	20	10	34	15	12.6
150	200	210	10	28830	285	240	22	8	20	10	34	15	10.6
200	250	280	10	53066	340	295	22	8	25	20	34	26	8.0
250	250	330	10	75439	395	350	22	12	25	20	34	26	6.4
300	250	384	10	104009	445	400	22	12	25	20	34	28	5.3
350	250	432	10	133249	505	460	22	16	25	20	34	27	4.6
400	250	484	13	169007	565	515	26	16	25	20	34	27	4.0
450	250	532	13	197823	615	565	26	20	30	20	34	27	3.6
500	250	585	13	241800	670	620	26	20	30	20	34	27	3.2
600	250	685	13	336785	780	725	30	20	30	20	34	27	2.9
700	250	786	13	448656	895	840	30	24	30	20	34	26	2.7
800	300	917	13	617614	1015	950	33	24	30	22	41	34	3.1
900	300	1017	13	764723	1115	1050	33	28	30	22	41	33	2.8
1000	300	1117	13	927532	1230	1160	36	28	30	22	41	33	2.5
1100	300	1217	13	1106041	1345	1270	36	32	30	22	41	33	2.3
1200	300	1317	13	1300250	1455	1380	39	32	30	22	41	32	2.1
1300	300	1417	13	1510159	1565	1485	42	32	30	22	41	32	1.9
1400	300	1517	13	1735768	1675	1590	42	36	30	22	41	31	1.8
1500	300	1617	13	1977077	1795	1705	48	36	30	22	41	31	1.7
1600	300	1717	13	2234086	1915	1820	48	40	30	22	41	31	1.6
1700	300	1817	13	2478817	2015	1920	48	44	35	22	41	30	1.5
1800	300	1917	13	2765656	2115	2020	48	44	35	22	41	30	1.4
1900	300	2017	13	3068195	2220	2125	48	48	35	22	41	29	1.3
2000	300	2117	13	3386434	2325	2230	48	48	35	22	41	29	1.3
2100	350	2255	13	3851387	2440	2335	56	48	35	24	47	38	1.4
2200	350	2355	13	4206992	2550	2440	56	52	35	24	47	37	1.3
2400	350	2555	13	4965302	2760	2650	56	56	35	24	47	36	1.1
2500	350	2655	13	5368007	2860	2750	56	56	35	24	47	36	1.1
2600	350	2755	13	5786412	2960	2850	56	60	35	24	47	35	1.1
2800	350	2955	13	6670322	3180	3070	56	64	35	24	47	34	1.0
3000	350	3155	13	7617032	3405	3290	62	68	35	24	47	33	0.9

*1 Overall lengths available from 150 mm to 450 mm.

*2 WF = effective area

*3 Other standards/dimensions possible.

*4 Movement absorption be increased by changing the the corrugation and overall length.

- Maximum size: DN 3000.

- Movement absorption is for a bellow design with 6 bar operating pressure.

Important information

Please note the appropriate fixed point constructions and plain bearings in your piping system, as well as the tolerances as per the FSA Handbook (page 118)!

For more information please refer to our installation instructions.

For information on the tie rods, please see the technical appendix (p. 89 - 92)!

++++ We will be happy to send you further information on the individual types and desings. +++++

WILLBRANDT Rubber Expansion Joint Type 42

Design E - with tie rods

For absorbing the expansion joint's reaction force in the direction of expansion while also absorbing high lateral movement.

The use of PTFE-coated spherical washers and conical sockets reduces the frictional force considerably during lateral movement. Can be used for vibration insulation and absorbing lateral movement.

Note: The number of tie rods is calculated from the available design data.

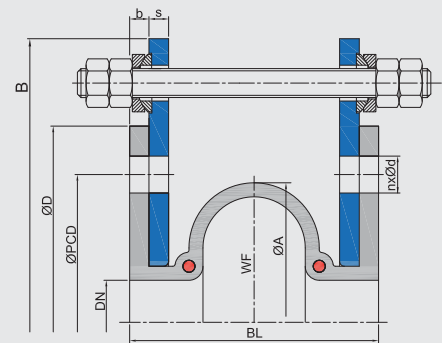

Design M - with tie rods/thrust limiters

For absorbing the expansion joint's reaction force in the direction of expansion while also absorbing high lateral movement and preventing the bellows from strong compression. The use of PTFE-coated spherical washers and conical sockets reduces the frictional force considerably during lateral movement. Can be used for vibration insulation and absorbing lateral movement. This design can also be used without spherical washers and conical sockets for dismantling (Design T).

Note: The number of tie rods is calculated from the available design data.

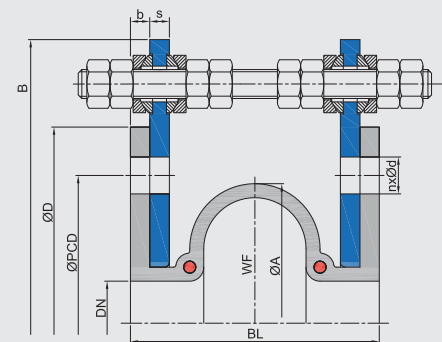

Design A - without tie rods, with filled corrugation

Can be used for movement absorption in any direction (for combined movements, see the movement diagram in the technical appendix), noise and vibration insulation.

The expansion joint's reaction force must be absorbed via suitable piping (see fitting instructions in the appendix).

Note: Limited movement absorption

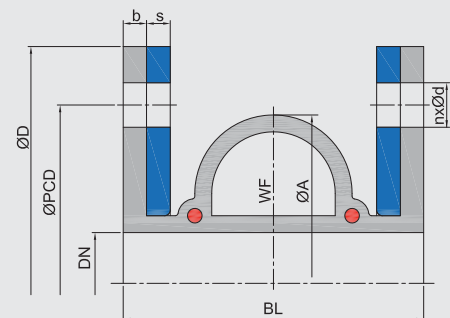

Important information

Please note the appropriate fixed point constructions and plain bearings in your piping system!
For more information please refer to our installation instructions. For information on the tie rods, please see the technical appendix (p. 89 - 92)!

++++ We will be happy to send you further information on the individual types and designs. +++++

