

WILLBRANDT Rubber Expansion Joint Type 50

DN 20 - DN 1000

Type 50 is a low-corrugated, highly elastic rubber expansion joint. Its low corrugation helps to achieve very low flow resistance. It reduces up to 70 % of the incoming energy. It is also characterise by very high movement absorption in all directions and variety of rubber qualities, which means that a suitable rubber compound is available for every application.

Type 50 is used in building technology, plant engineering, water and wastewater technology, engine construction, shipbuilding and in solar and wind plant engineering. It especially used where it is specifically used to absorb expansion and vibration and to insulate sound.

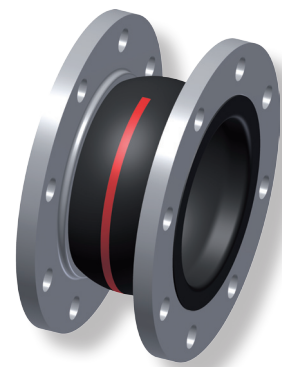

Bellow design

Low-corrugated rubber bellow with reinforcement and shaped sealing bead with core ring, self-sealing (no additional seals required). Suitable for accommodating swiveling flanges.

Flange version

Both sides with swiveling flange made of galvanized steel with clearance holes, drilled according to DIN PN 10 (standard). Other materials and dimensions are possible.

Approvals/Conformity

Similar to DIN 4809 / TÜV approved, drinking water and shipbuilding approval, FDA and EG 1935/2004 conform

Specifications for DN 20 - DN 400

Bellow		Bellow design			up to DN	Permissible operating data								Surface resistance Ro		
Colour code	Colour marking	Core (inner)	Reinforcement	Cover (outer)		°C bar		°C bar		°C bar		°C bar		Core	Cover	
red Sp	■ ■	EPDM	PEEK	EPDM	400	-40	10	70	16	100	10	130	8	150	4 x 10 ³	4 x 10 ³
red	■	IIR	Polyamide	EPDM	400	-40	10	50	16	70	12	100	10	120	7 x 10 ⁶	1 x 10 ³
red EPDM	■	EPDM	Polyamide	EPDM	400	-30	10	50	16	70	12	90	10	100	-	-
yellow	■	NBR	Polyamide	CR	400	-20	10	50	16	70	12	90	10	100	2 x 10 ²	1 x 10 ³
white	□	NBR	Polyamide	CR	400	-20	10	50	16	70	12	90	10	100	7 x 10 ⁹	1 x 10 ³
green	■	CSM	Polyamide	CSM	400	-20	10	50	16	70	12	100	10	110	7 x 10 ⁹	7 x 10 ⁹
orange	■	NBR	Polyamide	CR	200	-20	10	50	25	70	20	90	15	100	3 x 10 ³	1 x 10 ³
black EPDM*	◆	IIR	Polyamide	EPDM	150	-40	10	50	10	70	8	90	6	120	7 x 10 ⁶	1 x 10 ³
black CR	-	CR	Polyamide	CR	400	-25	10	50	16	70	12	90	10	100	7 x 10 ⁹	5 x 10 ¹⁰
yellow LT	■ LT	NBR-LT	Polyamide	CR	300	-40	10	50	16	70	12	90	10	100	1 x 10 ⁴	4 x 10 ³
yellow St	■ ■	NBR	Steel cord	CR	400	-20	10	60	16	70	12	90	10	100	2 x 10 ²	5 x 10 ¹⁰
yellow HNBR	■ ■ ■	HNBR	Steel cord	CR	300	-35	10	60	16	70	12	100	10	120	1,5 x 10 ⁵	- 10 ¹⁰

Bursting pressure DN 20 - 400 > 48 bar
 * Bursting pressure max. 30 bar, max. DN 150

For pressure loss see technical appendix.

Specifications for DN 450 - DN 1000

Bellow		Bellow design			up to DN	Permissible operating data								Surface resistance Ro		
Colour code	Colour marking	Core (inner)	Reinforcement	Cover (outer)		°C bar		°C bar		°C bar		°C bar		Core	Cover	
red Sp	■ ■	EPDM	PEEK	EPDM	1000	-40	8	70	10	100	7,5	130	6	150	4 x 10 ³	4 x 10 ³
red	■	IIR	Polyamide	EPDM	1000	-40	8	50	10	70	8	100	6	120	7 x 10 ⁶	1 x 10 ³
red EPDM	■	EPDM	Polyamide	EPDM	600	-30	8	50	10	70	8	90	6	100	-	-
yellow	■	NBR	Polyamide	CR	1000	-20	8	50	10	70	8	90	6	100	2 x 10 ²	1 x 10 ³
white	□	NBR	Polyamide	CR	600	-20	8	50	10	70	8	90	6	100	7 x 10 ⁹	1 x 10 ³
green	■	CSM	Polyamide	CSM	1000	-20	8	50	10	70	8	100	6	110	7 x 10 ⁹	7 x 10 ⁹
black CR	-	CRN	Polyamide	CR	1000	-25	8	50	10	70	8	90	6	100	7 x 10 ⁹	5 x 10 ¹⁰
yellow St	■ ■	NBR	Steel cord	CR	600	-20	8	60	10	70	8	90	6	100	2 x 10 ²	5 x 10 ¹⁰

Bursting pressure DN 450 - 1000 > 30 bar

For pressure loss see technical appendix.

Important information

For aggressive media, please see the resistance table (can be requested separately).
 The bellows should not be painted or insulated. Please refer to the installation instructions.
 ++++ We will be happy to send you further information on the individual types and designs. ++++

WILLBRANDT Rubber Expansion Joint Type 50

Vacuum resistance

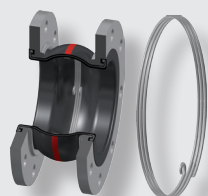

- DN 20 to 50 vacuum-resistant without additional accessories
- DN 65 to 250 without additional accessories to -300 mbar and with vacuum supporting spiral for full vacuum
- DN 300 to DN 1000 only vacuum-resistant with vacuum supporting ring
- Type 50 black EPDM DN 20 to DN 40 without additional accessories

to -300 mbar and with vacuum supporting spiral for full vacuum

Accessories

- Guide sleeves
- Potential equalisation
- Flame-resistant protective covers
- Dust and splash protection covers
- Earth cover / sun protection hoods
- Segment tie rods

Application

Type 50 red Sp

For heating installations according to DIN 4809. For many years of operation under constant loading with hot water and heating water at 100 °C/110 °C at 10 bar/6 bar operating pressure. Electrically conductive surface. Not suitable for media with additives containing oil.

Type 50 red

For drinking water, hot water, sea water, cooling water with chemical additives for treating water, saline solutions, weak acids and weak alkaline solutions. Electrically dissipative inner surface and electrically conductive outer surface. Not suitable for oil products or cooling water with additives containing oil.

Type 50 red EPDM

Like Type 50 red, but not for drinking water, shipbuilding and offshore applications. Temperature range max. 90 °C at 10 bar.

Type 50 yellow

For oils, lubricants, fuels, gases, city and natural gas (not liquefied) and DIN EN fuels with an aromatic content up to 50 %. Electrically conductive.

Type 50 white

For foodstuffs containing oil and fat (rubber in food-grade). Not approved for drinking water. Electrically insulating inner surface and electrically conductive outer surface.

Type 50 green

For chemicals, aggressive chemical wastewater and compressor air containing oil. Electrically insulating.

Type 50 orange

Like Type 50 yellow, but also for liquid petroleum gas acc. to DIN EN 589. Electrically dissipative.

Type 50 black EPDM

For drinking water, sea water, cooling water, weak acids and alkali solutions, technical alcohols, esters and ketones. Max. pressure 10 bar. Electrically dissipative inner surface and electrically conductive outer surface.

Type 50 black CR

For hot and cold water, wastewater, swimming pool water, salt water, wastewater, cooling water with anti-corrosive products containing oil, oil mixtures and compressed air containing oil. Electrically insulating.

Type 50 yellow LT

Like Type 50 yellow, but also for liquid gas. Electrically dissipative.

Type 50 lilac

For flue gas desulphurisation systems and bio-diesel. Good resistance to benzene, xylene, toluene, fuels with an aromatic content of more than 50 %, aromatic/chlorinated hydrocarbons and mineral acids. Electrically insulating inner surface and electrically conductive outer surface.

Type 50 yellow St

Like Type 50 yellow with additional flame-resistance for up to 30 minutes at 800 °C. Electrically conductive inner surface, electrically insulating outer surface.

Type 50 yellow HNBR

Like Type 50 yellow St, but for temperatures up to +100 °C. Electrically dissipative inner surface, electrically insulating outer surface.

Note!

Detailed material descriptions on pages 5 - 7.

WILLBRANDT Rubber Expansion Joint Type 50

Design A - without tie rods

Can be used for movement absorption in any direction (for combined movements, see the movement diagram in the technical appendix), noise and vibration insulation.

The expansion joint's reaction force must be absorbed via suitable piping.

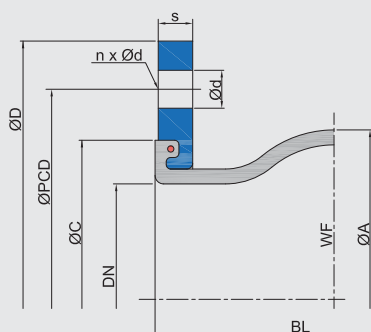

Dimensions for Design A

DN	Length BL mm	Bellow		Flange PN 10*2						Movement absorption (polyamide cord)				Movement absorption (steel cord)				Weight kg
		ØA mm	WF*1 mm ²	ØD mm	ØPCD mm	Ød mm	n	s mm	ØC mm	axial + mm	axial - mm	lateral ± mm	angular ± ∠°	axial + mm	axial - mm	lateral ± mm	angular ± ∠°	
20	130	81	1700	105	75	12	4	14	66	30	30	30	30	15	30	15	20	1.5
25	130	81	1700	115	85	14	4	14	66	30	30	30	30	15	30	15	20	1.9
32	130	81	1700	140	100	18	4	15	66	30	30	30	30	15	30	15	20	3.1
40	130	86	1800	150	110	18	4	15	74	30	30	30	30	15	30	15	20	3.5
50	130	96	3200	165	125	18	4	16	86	30	30	30	30	15	30	15	20	3.7
65	130	111	5300	185	145	18	8	16	106	30	30	30	30	15	30	15	20	5.3
80	130	122	8500	200	160	18	8	18	118	30	30	30	30	15	30	15	20	6.8
100	130	142	12800	220	180	18	8	18	138	30	30	30	20	15	30	15	15	7.9
125	130	168	18700	250	210	18	8	18	166	30	30	30	20	15	30	15	15	9.6
150	130	192	25900	285	240	22	8	18	192	30	30	30	20	15	30	15	15	12.9
200	130	252	41000	340	295	22	8	20	252	30	30	30	12	20	15	10	5	16.2
250	130	302	59600	395	350	22	12	20	304	30	30	30	12	20	15	10	5	21.5
300	130	354	82200	445	400	22	12	22	354	30	30	30	12	20	15	10	5	24.5
350	200	420	117600	505	460	22	16	24	412	30	50	30	8	30	30	25	10	38.3
400	200	480	154700	565	515	26	16	25	470	30	50	30	8	30	40	25	5	38.0
450	200	530	204200	615	565	26	20	28	520	30	50	30	8	-	-	-	-	47.2
500	200	580	227900	670	620	26	20	30	570	30	50	30	8	-	-	-	-	56.5
600	200	680	311500	780	725	30	20	30	675	30	50	30	8	-	-	-	-	75.2
700	*3250	800	434200	895	840	30	24	35	780	30	50	30	8	-	-	-	-	127.8
800	250	880	527400	1015	950	33	24	40	887	30	50	30	6	-	-	-	-	161.0
900	300	1038	737900	1115	1050	33	28	40	987	30	50	30	5	-	-	-	-	196.7
1000	300	1138	889400	1230	1160	36	28	40	1087	30	50	30	5	-	-	-	-	234.5

*1 WF = effective area

*2 Other standards/dimensions possible.

*3 Building length 260 mm

Permissible degree of utilisation for movement areas:

- up to 50 °C: Utilisation ~ 100 %
- up to 70 °C: Utilisation ~ 75 %
- up to 90 °C: Utilisation ~ 60 %

Important information

Please note the appropriate fixed point constructions and plain bearings in your piping system!

For more information please refer to our installation instructions.

For information on the tie rods, please see the technical appendix (p. 89 - 92)!

++++ We will be happy to send you further information on the individual types and designs. +++++

WILLBRANDT Rubber Expansion Joint Type 50

Length limiters

There is a selection of various length limiters / tie rods to absorb the reaction force and to protect the bellow from overstretching or collapsing:

Design B*
with tie rods

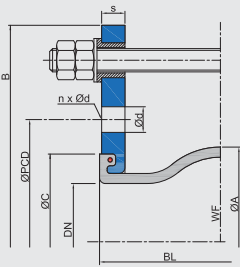

Design C*
with tie rods/thrust limiters

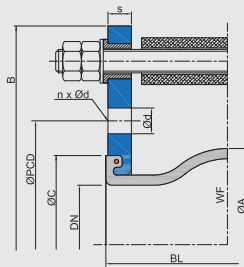

Design E
with tie rods and spherical washers/conical sockets

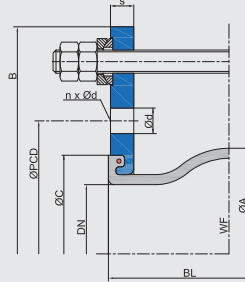

Design M
with tie rods/thrust limiters and spherical washers/conical sockets

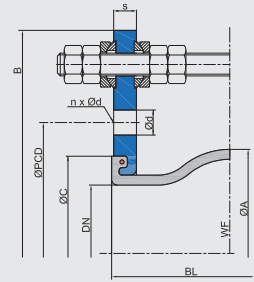

Design F
with hinge

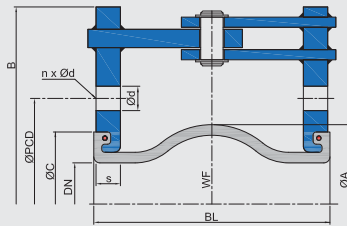

*Note: For Designs B and C the lateral movement absorption is reduced by around 50 %.

Flange dimensions for Designs with tie rods

DN	Length BL	Flange PN 10 (example dimensions)						
		B	ØD	ØPCD	Ød	n	s	ØC
	mm	mm	mm	mm	mm		mm	mm
20	130	189	105	75	12	4	14	66
25	130	205	115	85	14	4	14	66
32	130	230	140	100	18	4	15	66
40	130	240	150	110	18	4	15	74
50	130	255	165	125	18	4	16	86
65	130	275	185	145	18	8	16	106
80	130	290	200	160	18	8	18	118
100	130	310	220	180	18	8	18	138
125	130	340	250	210	18	8	18	166
150	130	375	285	240	22	8	18	192
200	130	440	340	295	22	8	20	252
250	130	509	395	350	22	12	20	304
300	130	559	445	400	22	12	22	354
350	200	619	505	460	22	16	24	412
400	200	700	565	515	26	16	25	470
450	200	760	615	565	26	20	30	520
500	200	810	670	620	26	20	30	570
600	200	930	780	725	30	20	30	675
700	*250	1045	895	840	30	24	35	780
800	250	1175	1015	950	33	24	40	887
900	300	1285	1115	1050	33	28	40	987
1000	300	1400	1230	1160	36	28	40	1087

* Building length 260 mm

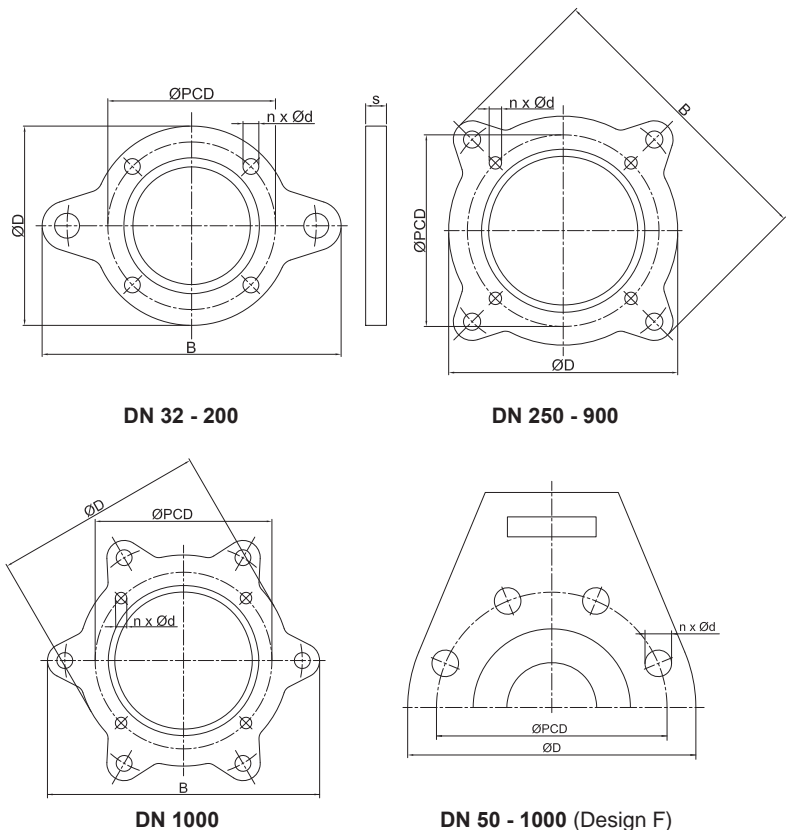

WILLBRANDT Rubber Expansion Joint Type 50

Axial stiffness rates

DN	Overall length BL mm		Stiffness rates (averages value from full way)				
			0 bar Nm/mm	2,5 bar Nm/mm	4 bar Nm/mm	6 bar Nm/mm	10 bar Nm/mm
20	130	31	68	128	192	243	270
25	130	31	68	128	192	243	270
32	130	31	68	128	192	243	270
40	130	30	66	124	186	236	261
50	130	25	51	98	134	173	192
65	130	24	53	100	150	190	211
80	130	28	58	104	148	185	205
100	130	35	71	116	206	274	304
125	130	36	71	137	214	282	313
150	130	49	102	189	293	390	433
200	130	100	180	365	568	735	816
250	130	105	207	388	609	778	864
300	130	123	248	448	658	883	980
350	200	105	177	349	567	753	836
400	200	154	261	516	535	1090	1210
450	200	167	320	581	903	1162	1290
500	200	196	376	686	1060	1364	1514
600	200	208	292	692	1123	1441	1600
700	*250	140	198	521	714	954	-
800	250	180	270	594	975	1258	-
900	300	200	380	690	1080	1395	-
1000	300	225	420	742	1248	1568	-

* Building length 260 mm

Warning: Deviations (+/- 25 %) in the stiffness rates may occur due to use of different materials and manufacturing processes.

Lateral stiffness rates

DN	Overall length BL mm		Stiffness rates (averages value from full way)				
			0 bar Nm/mm	2,5 bar Nm/mm	4 bar Nm/mm	6 bar Nm/mm	10 bar Nm/mm
20	130	64	125	184	240	240	300
25	130	64	125	184	240	240	300
32	130	64	125	184	240	240	300
40	130	62	121	178	233	256	291
50	130	50	65	80	105	145	205
65	130	40	78	115	150	165	188
80	130	35	74	136	155	173	200
100	130	55	88	143	168	192	228
125	130	100	200	261	293	383	518
150	130	120	260	309	366	466	616
200	130	323	723	836	949	1219	1624
250	130	379	806	1022	1173	1479	1938
300	130	392	837	1068	1216	1542	2031
350	200	305	610	762	875	1098	1433
400	200	338	642	817	946	1199	1579
450	200	342	639	821	971	1200	1544
500	200	426	818	1048	1204	1495	1932
600	200	456	834	1062	1295	1586	2023
700	*250	516	939	1191	1449	1775	-
800	250	558	960	1055	1557	1758	-
900	300	800	1480	1984	2248	2560	-
1000	300	960	1824	2361	2736	2976	-

* Building length 260 mm

Warning: Deviations (+/- 25 %) in the stiffness rates may occur due to use of different materials and manufacturing processes.



WILLBRANDT Rubber Expansion Joint Type 50

Angular stiffness torque

DN	Overall length BL mm		Stiffness torque (averages value from full way)					
			0 bar Nm/°	2,5 bar Nm/°	4 bar Nm/°	6 bar Nm/°	10 bar Nm/°	16 bar Nm/°
20	130	130	0.2	0.5	0.9	1.3	1.7	1.9
25	130	130	0.2	0.5	0.9	1.3	1.7	1.9
32	130	130	0.2	0.5	0.9	1.3	1.7	1.9
40	130	130	0.3	0.6	1.1	1.6	2.0	2.3
50	130	130	0.3	0.6	1.1	1.6	2.0	2.2
65	130	130	0.4	0.9	1.7	2.5	3.2	3.6
80	130	130	1.0	1.0	2.0	3.0	4.0	5.0
100	130	130	1.0	2.0	4.0	7.0	9.0	10.0
125	130	130	2.0	3.0	6.0	10.0	13.0	15.0
150	130	130	3.0	7.0	12.0	19.0	25.0	28.0
200	130	130	11.0	20.0	41.0	63.0	82.0	91.0
250	130	130	18.0	35.0	65.0	102.0	130.0	144.0
300	130	130	29.0	58.0	105.0	154.0	206.0	229.0
350	200	200	34.0	57.0	113.0	183.0	244.0	270.0
400	200	200	65.0	110.0	218.0	226.0	460.0	511.0
450	200	200	87.0	168.0	304.0	473.0	609.0	676.0
500	200	200	125.0	239.0	436.0	674.0	868.0	963.0
600	200	200	186.0	261.0	618.0	1004.0	1288.0	1429.0
700	*250	250	167.0	237.0	861.0	853.0	1140.0	-
800	250	250	277.0	416.0	914.0	1501.0	1937.0	-
900	300	300	386.0	733.0	1330.0	2082.0	2689.0	-
1000	300	300	531.0	991.0	1751.0	2945.0	3700.0	-

* Building length 260 m

Warning: Deviations (+/- 25 %) in the stiffness torque may occur due to use of different materials and manufacturing processes.

Frictional force

DN	Overall length BL mm		Frictional force	
			For designs E and M N/bar	for design F frictional moment Nm/bar
20	130	7	0.2	
25	130	7	0.2	
32	130	7	0.2	
40	130	7	0.2	
50	130	12	0.3	
65	130	20	0.5	
80	130	35	1.0	
100	130	51	1.4	
125	130	75	2.1	
150	130	118	4.4	
200	130	167	6.2	
250	130	243	11.2	
300	130	335	15.4	
350	200	120	17.0	
400	200	160	22.9	
450	200	171	40.5	
500	200	266	63.5	
600	200	634	138.5	
700	*250	662	180.9	
800	250	896	326.2	
900	250	1105	402.4	
1000	250	1357	617.3	

* Building length 260 m

Warning: Deviations (+/- 25 %) in the frictional force may occur due to use of different materials and manufacturing processes.



WILLBRANDT Chemical Expansion Joint Type 50 PTFE

DN 25 - DN 500

Type 50 PTFE is a low-corrugated, PTFE-lined rubber expansion joint. Its low corrugation helps to achieve very low flow resistance. The PTFE lining gives the expansion joint high chemical resistance or an anti-adhesive property.

The PTFE lining can be used for any rubber compound on Type 50. It is however necessary to ensure that the selected rubber compound achieves the highest possible media resistance, as this is the only way to achieve optimum service life.



Dimensions for Design A

DN	Length BL mm	Bellows		ØD mm	ØPCD mm	Flange PN 10			ØC mm	Movement absorption				Weight kg
		ØA mm	WF* mm ²			Ød mm	n	s mm		axial + mm	axial - mm	lateral ± mm	angular ± ∠°	
25	130	81	1700	115	85	14	4	14	66	15	15	15	15.0	1.9
32	130	81	1700	140	100	18	4	15	66	15	15	15	15.0	3.1
40	130	86	1800	150	110	18	4	15	74	15	15	15	15.0	3.5
50	130	96	3200	165	125	18	4	16	86	15	15	15	15.0	3.8
65	130	111	5300	185	145	18	8	16	106	15	15	15	15.0	5.4
80	130	122	8500	200	160	18	8	18	118	15	15	15	15.0	6.9
100	130	142	12800	220	180	18	8	18	138	15	15	15	10.0	8.0
125	130	168	18700	250	210	18	8	18	166	15	15	15	10.0	9.7
150	130	192	25900	285	240	22	8	20	192	15	15	15	10.0	13.1
200	130	252	41000	340	295	22	8	20	252	15	15	15	6.0	16.4
250	130	302	59600	395	350	22	12	20	304	15	15	15	6.0	21.7
300	130	354	82200	445	400	22	12	20	354	15	15	15	6.0	24.8
350	200	420	117600	505	460	22	16	24	412	15	15	15	4.0	38.8
400	200	480	154700	565	515	26	16	25	470	15	15	15	4.0	38.6
450	200	530	204200	615	565	26	20	28	520	15	15	15	4.0	49.3
500	200	580	227900	670	620	26	20	30	570	15	15	15	4.0	57.2

* WF = effective area

Permissible degree of utilisation for movement areas:

- up to 50 °C: Utilisation ~ 100 %
- up to 70 °C: Utilisation ~ 75 %
- up to 90 °C: Utilisation ~ 60 %

Pressure resistance Max. 6 bar operating pressure with polyamide cord reinforcement, max. 9 bar operating pressure with aramid or steel cord reinforcement.

Conformity FDA and EG 1935/2004

Vacuum resistance Only limited suitable for vacuum operation. A PTFE vacuum supporting ring, which allows full vacuum for small nominal diameters, can be used from DN 50. The PTFE supporting ring can only be used up to 50 °C. DN 25, DN 32, DN 40 and DN 350 expansion joints are not suitable for vacuum operation.

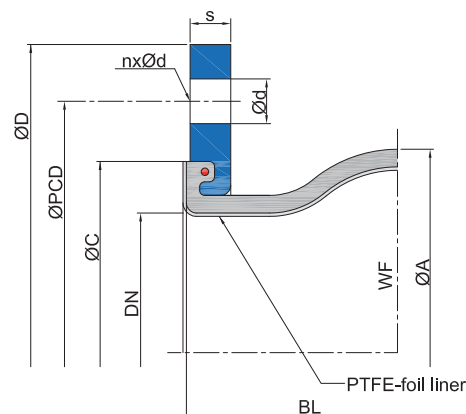

Important information

For aggressive media, please see the resistance table (can be requested separately). The bellows should not be painted or insulated. Please refer to the installation instructions.
++++ We will be happy to send you further information on the individual types and designs. +++++